

PESDxL1BA series

Low capacitance bidirectional ESD protection diodes in SOD323

Rev. 01 — 4 October 2004

Product data sheet

1. Product profile

1.1 General description

Bidirectional ElectroStatic Discharge (ESD) protection diodes in a very small SOD323 (SC-76) SMD plastic package designed to protect one signal line from the damage caused by ESD and other transients.

1.2 Features

- Bidirectional ESD protection of one line
- Max. peak pulse power: $P_{pp} = 500 \text{ W}$
- Low clamping voltage: $V_{(CL)R} = 26 \text{ V}$
- Ultra low leakage current: $I_{RM} < 0.09 \mu\text{A}$
- ESD protection $> 23 \text{ kV}$
- IEC 61000-4-2, level 4 (ESD)
- IEC 61000-4-5 (surge); $I_{pp} = 18 \text{ A}$
- Very small SMD plastic package.

1.3 Applications

- Computers and peripherals
- Communication systems
- Audio and video equipment
- Data lines
- CAN bus protection.

1.4 Quick reference data

Table 1: Quick reference data

Symbol	Parameter	Conditions	Min	Typ	Max	Unit
V_{RWM}	reverse stand-off voltage					
	PESD3V3L1BA		-	-	3.3	V
	PESD5V0L1BA		-	-	5.0	V
	PESD12VL1BA		-	-	12	V
	PESD15VL1BA		-	-	15	V
	PESD24VL1BA		-	-	24	V
C_d	diode capacitance	$V_R = 0 \text{ V};$ $f = 1 \text{ MHz}$				
	PESD3V3L1BA		-	101	-	pF
	PESD5V0L1BA		-	75	-	pF
	PESD12VL1BA		-	19	-	pF
	PESD15VL1BA		-	16	-	pF
	PESD24VL1BA		-	11	-	pF

PHILIPS

2. Pinning information

Table 2: Pinning

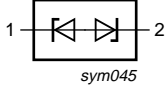
Pin	Description	Simplified outline	Symbol
1	cathode 1		
2	cathode 2		

3. Ordering information

Table 3: Ordering information

Type number	Package		
	Name	Description	Version
PESDxL1BA series	SC-76	plastic surface mounted package; 2 leads	SOD323

4. Marking

Table 4: Marking codes

Type number	Marking code
PESD3V3L1BA	AB
PESD5V0L1BA	AC
PESD12VL1BA	AD
PESD15VL1BA	AE
PESD24VL1BA	AF

5. Limiting values

Table 5: Limiting values

In accordance with the Absolute Maximum Rating System (IEC 60134).

Symbol	Parameter	Conditions	Min	Max	Unit
P _{pp}	peak pulse power	8/20 μs	[1]		
	PESD3V3L1BA		-	500	W
	PESD5V0L1BA		-	500	W
	PESD12VL1BA		-	200	W
	PESD15VL1BA		-	200	W
	PESD24VL1BA		-	200	W
I _{pp}	peak pulse current	8/20 μs	[1]		
	PESD3V3L1BA		-	18	A
	PESD5V0L1BA		-	15	A
	PESD12VL1BA		-	5	A
	PESD15VL1BA		-	5	A
	PESD24VL1BA		-	3	A
T _j	junction temperature		-	150	°C
T _{amb}	ambient temperature		-65	+150	°C
T _{stg}	storage temperature		-65	+150	°C

[1] Non-repetitive current pulse 8/20 μs exponential decay waveform; see [Figure 1](#).

Table 6: ESD maximum ratings

Symbol	Parameter	Conditions	Min	Max	Unit
ESD	electrostatic discharge capability	IEC 61000-4-2 (contact discharge)	[1]		
	PESD3V3L1BA		-	30	kV
	PESD5V0L1BA		-	30	kV
	PESD12VL1BA		-	30	kV
	PESD15VL1BA		-	30	kV
	PESD24VL1BA		-	23	kV
	PESDxL1BA series	HBM MIL-Std 883	-	10	kV

[1] Device stressed with ten non-repetitive ESD pulses; see [Figure 2](#).

Table 7: ESD standards compliance

Standard	Conditions
IEC 61000-4-2; level 4 (ESD); Figure 2	> 15 kV (air); > 8 kV (contact)
HBM MIL-Std 883; class 3	> 4 kV

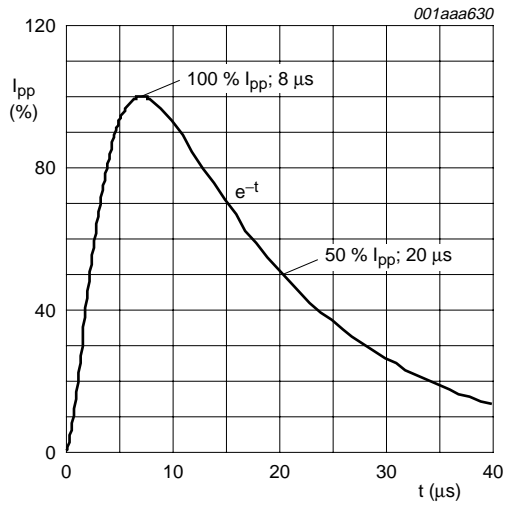

Fig 1. 8/20 μs pulse waveform according to IEC 61000-4-5.

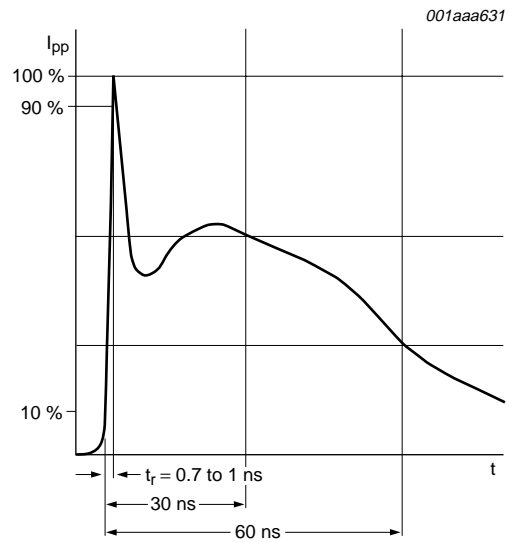

Fig 2. ESD pulse waveform according to IEC 61000-4-2.

6. Characteristics

Table 8: Characteristics
 $T_{amb} = 25\text{ }^{\circ}\text{C}$ unless otherwise specified.

Symbol	Parameter	Conditions	Min	Typ	Max	Unit
V_{RWM}	reverse stand-off voltage					
	PESD3V3L1BA		-	-	3.3	V
	PESD5V0L1BA		-	-	5.0	V
	PESD12VL1BA		-	-	12	V
	PESD15VL1BA		-	-	15	V
	PESD24VL1BA		-	-	24	V
I_{RM}	reverse leakage current	see Figure 7				
	PESD3V3L1BA	$V_{RWM} = 3.3\text{ V}$	-	0.09	2	μA
	PESD5V0L1BA	$V_{RWM} = 5.0\text{ V}$	-	0.01	1	μA
	PESD12VL1BA	$V_{RWM} = 12\text{ V}$	-	< 1	50	nA
	PESD15VL1BA	$V_{RWM} = 15\text{ V}$	-	< 1	50	nA
	PESD24VL1BA	$V_{RWM} = 24\text{ V}$	-	< 1	50	nA
$V_{(BR)}$	breakdown voltage	$I_R = 5\text{ mA}$				
	PESD3V3L1BA		5.8	6.4	6.9	V
	PESD5V0L1BA		7.0	7.6	8.2	V
	PESD12VL1BA		14.2	15.9	16.7	V
	PESD15VL1BA		17.1	18.9	20.3	V
	PESD24VL1BA		25.4	27.8	30.3	V
C_d	diode capacitance	$V_R = 0\text{ V}$; $f = 1\text{ MHz}$; see Figure 5 and 6				
	PESD3V3L1BA		-	101	-	pF
	PESD5V0L1BA		-	75	-	pF
	PESD12VL1BA		-	19	-	pF
	PESD15VL1BA		-	16	-	pF
	PESD24VL1BA		-	11	-	pF
$V_{(CLR)}$	clamping voltage		[1]			
	PESD3V3L1BA	$I_{pp} = 1\text{ A}$	-	-	8	V
		$I_{pp} = 18\text{ A}$	-	-	26	V
	PESD5V0L1BA	$I_{pp} = 1\text{ A}$	-	-	10	V
		$I_{pp} = 15\text{ A}$	-	-	33	V
	PESD12VL1BA	$I_{pp} = 1\text{ A}$	-	-	20	V
		$I_{pp} = 5\text{ A}$	-	-	37	V
	PESD15VL1BA	$I_{pp} = 1\text{ A}$	-	-	25	V
		$I_{pp} = 5\text{ A}$	-	-	44	V
	PESD24VL1BA	$I_{pp} = 1\text{ A}$	-	-	40	V
		$I_{pp} = 3\text{ A}$	-	-	70	V

Table 8: Characteristics ...continued
 $T_{amb} = 25\text{ }^{\circ}\text{C}$ unless otherwise specified.

Symbol	Parameter	Conditions	Min	Typ	Max	Unit
r_{dif}	differential resistance	$I_R = 1\text{ mA}$				
	PESD3V3L1BA		-	-	400	Ω
	PESD5V0L1BA		-	-	80	Ω
	PESD12VL1BA		-	-	200	Ω
	PESD15VL1BA		-	-	225	Ω
	PESD24VL1BA		-	-	300	Ω

[1] Non-repetitive current pulse 8/20 μs exponential decay waveform; see [Figure 1](#).

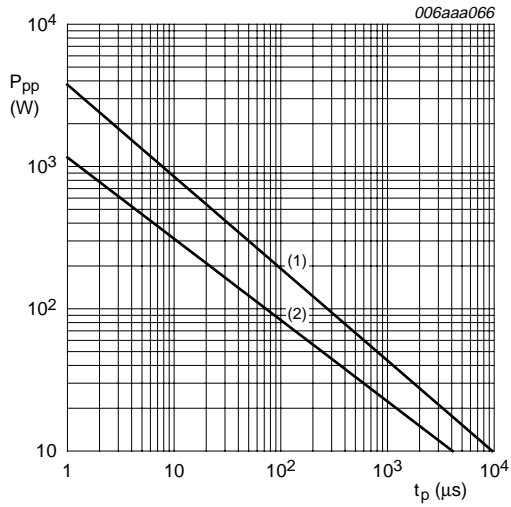

$T_{amb} = 25\text{ }^\circ\text{C}$.

$t_p = 8/20\text{ }\mu\text{s}$ exponential decay waveform; see Figure 1.

- (1) PESD3V3L1BA and PESD5V0L1BA.
- (2) PESD12VL1BA; PESD15VL1BA; PESD24VL1BA.

Fig 3. Peak pulse power dissipation as a function of pulse time; typical values.

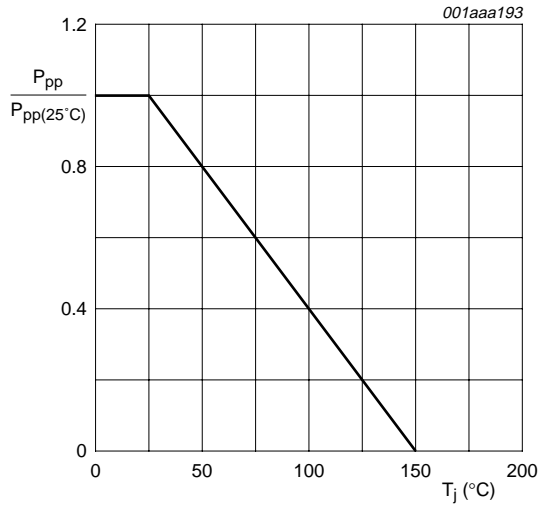
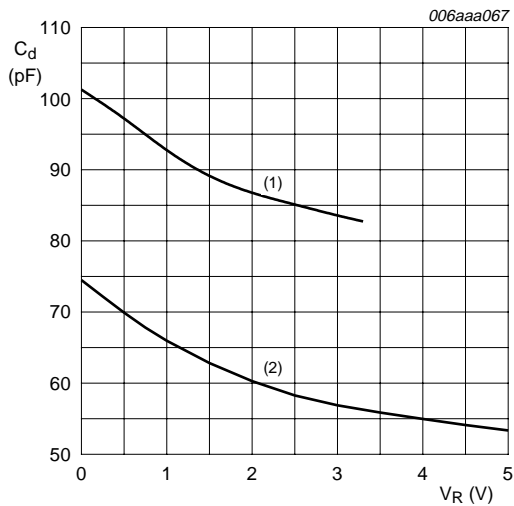

Fig 4. Relative variation of peak pulse power as a function of junction temperature; typical values.



$T_{amb} = 25\text{ }^\circ\text{C}$; $f = 1\text{ MHz}$.

- (1) PESD3V3L1BA.
- (2) PESD5V0L1BA.

Fig 5. Diode capacitance as a function of reverse voltage; typical values.

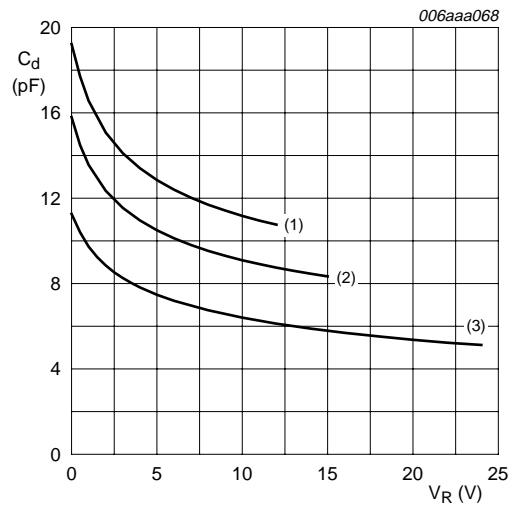

$T_{amb} = 25\text{ }^\circ\text{C}$; $f = 1\text{ MHz}$.

- (1) PESD12VL1BA.
- (2) PESD15VL1BA.
- (3) PESD24VL1BA.

Fig 6. Diode capacitance as a function of reverse voltage; typical values.

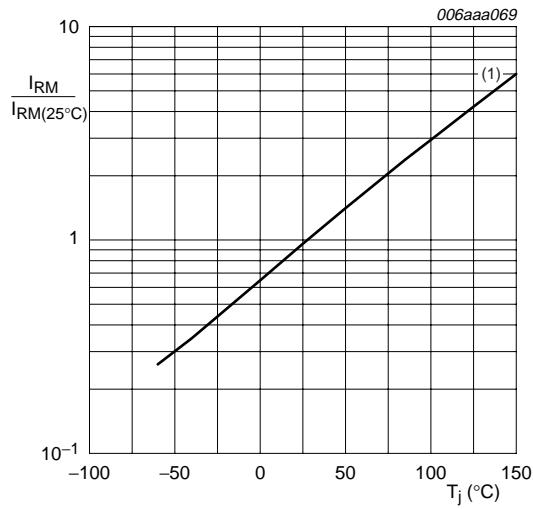

(1) PESD3V3L1BA; PESD5V0L1BA.

For PESD12VL1BA, PESD15VL1BA and PESD24VL1BA, $I_{RM} < 20 \text{ nA}$ at $150 \text{ }^\circ\text{C}$.

Fig 7. Relative variation of reverse leakage current as a function of junction temperature; typical values.

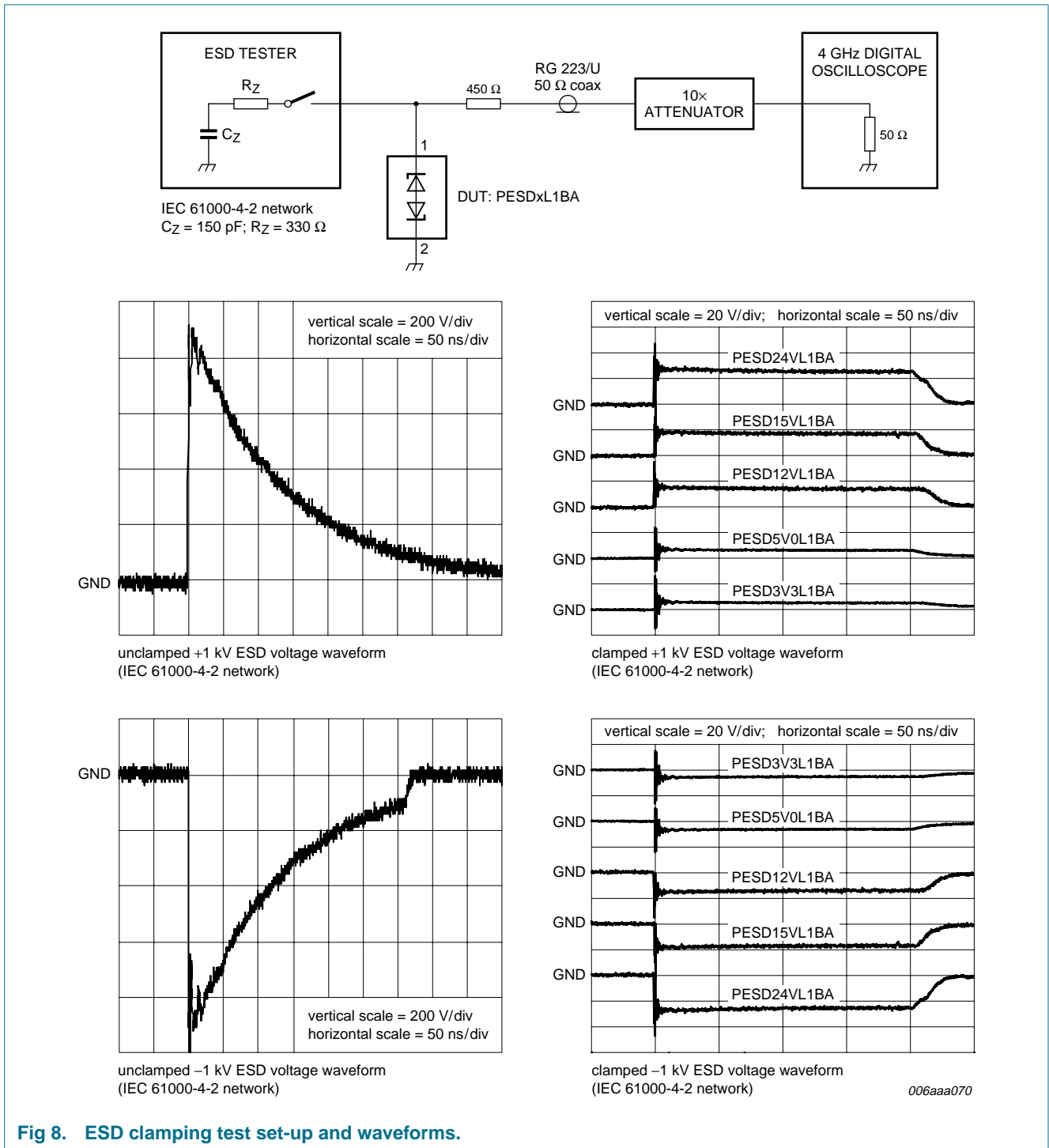

Fig 8. ESD clamping test set-up and waveforms.

7. Application information

The PESDxL1BA series is designed for bidirectional protection of one signal line from the damage caused by Electro Static Discharge (ESD) and surge pulses. The PESDxL1BA series may be used on lines where the signal polarity is above and below ground. The PESDxL1BA series provides a surge capability of up to 500 W per line for a 8/20 μ s waveform.

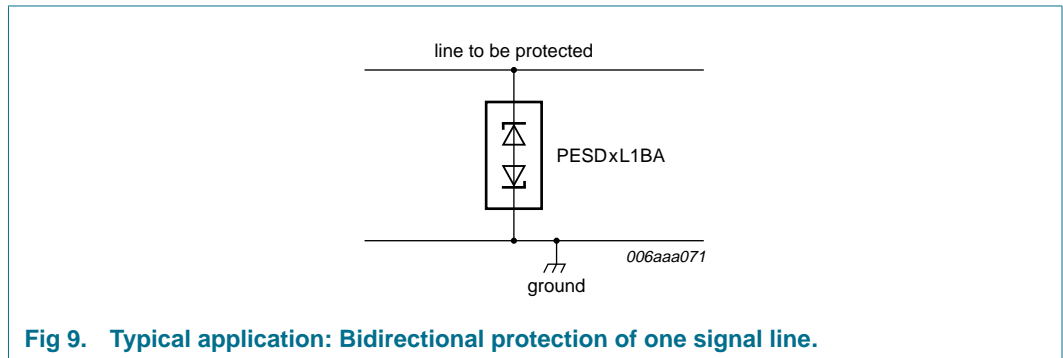

Fig 9. Typical application: Bidirectional protection of one signal line.

Circuit board layout and protection device placement

Circuit board layout is critical for the suppression of ESD, Electrical Fast Transient (EFT) and surge transients. The following guidelines are recommended:

1. Place the protection device as close to the input terminal or connector as possible.
2. The path length between the protection device and the protected line should be minimized.
3. Keep parallel signal paths to a minimum.
4. Avoid running protected conductors in parallel with unprotected conductor.
5. Minimize all printed-circuit board conductive loops including power and ground loops.
6. Minimize the length of the transient return path to ground.
7. Avoid using shared transient return paths to a common ground point.
8. Ground planes should be used whenever possible. For multilayer printed-circuit boards, use ground vias.

8. Package outline

Plastic surface mounted package; 2 leads

SOD323

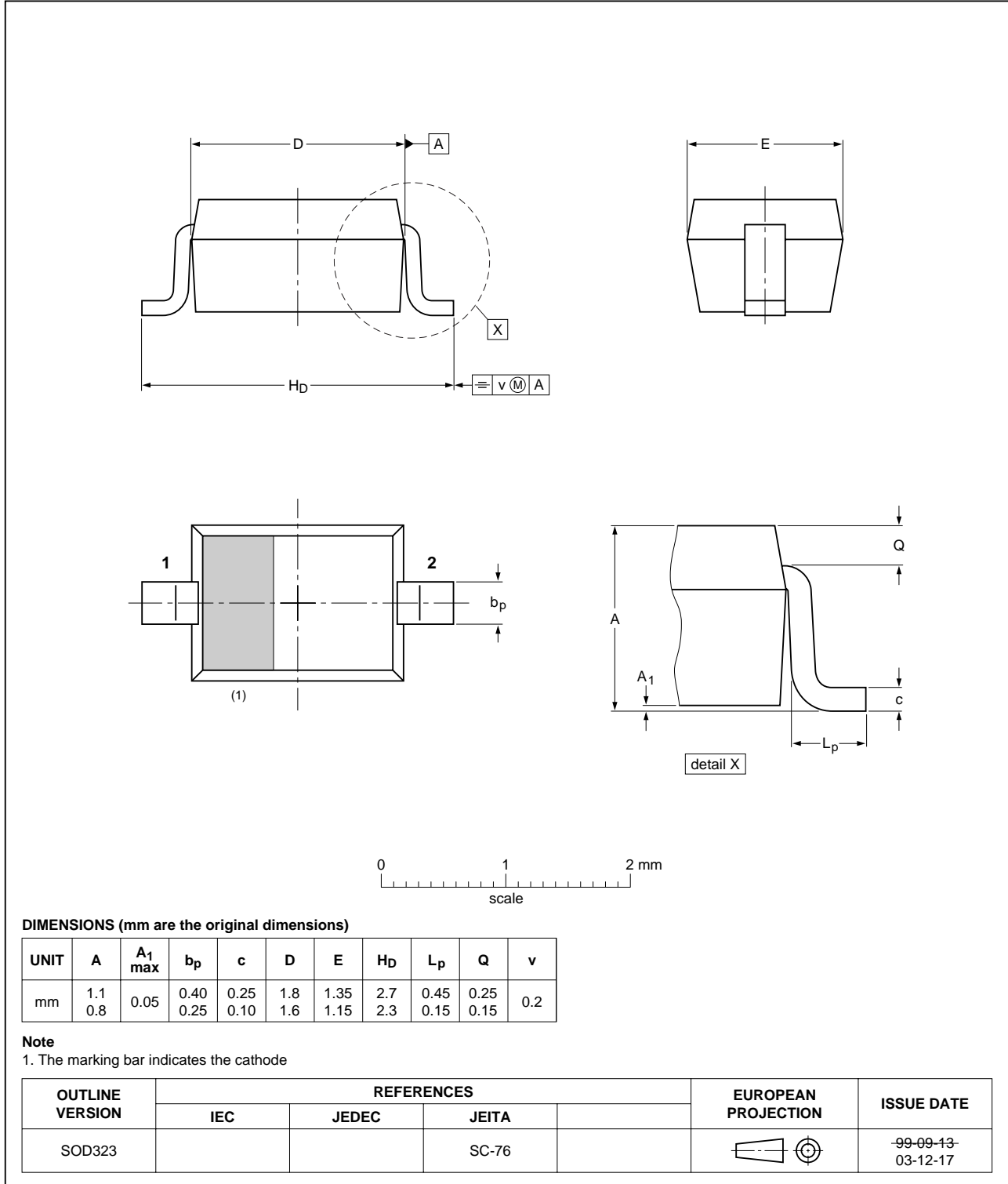

Fig 10. Package outline SOD323 (SC-76).

9. Packing information

Table 9: Packing methods

The indicated -xxx are the last three digits of the 12NC ordering code. [\[1\]](#)

Type number	Package	Description	Packing quantity	
			3000	10000
PESDxL1BA series	SOD323	4 mm pitch, 8 mm tape and reel	-115	-135

[1] For further information and the availability of packing methods, see [Section 14](#).

10. Revision history

Table 10: Revision history

Document ID	Release date	Data sheet status	Change notice	Doc. number	Supersedes
PESDXL1BA_SER_1	20041004	Product data sheet	-	9397 750 13595	-

11. Data sheet status

Level	Data sheet status ^[1]	Product status ^[2] ^[3]	Definition
I	Objective data	Development	This data sheet contains data from the objective specification for product development. Philips Semiconductors reserves the right to change the specification in any manner without notice.
II	Preliminary data	Qualification	This data sheet contains data from the preliminary specification. Supplementary data will be published at a later date. Philips Semiconductors reserves the right to change the specification without notice, in order to improve the design and supply the best possible product.
III	Product data	Production	This data sheet contains data from the product specification. Philips Semiconductors reserves the right to make changes at any time in order to improve the design, manufacturing and supply. Relevant changes will be communicated via a Customer Product/Process Change Notification (CPCN).

[1] Please consult the most recently issued data sheet before initiating or completing a design.

[2] The product status of the device(s) described in this data sheet may have changed since this data sheet was published. The latest information is available on the Internet at URL <http://www.semiconductors.philips.com>.

[3] For data sheets describing multiple type numbers, the highest-level product status determines the data sheet status.

12. Definitions

Short-form specification — The data in a short-form specification is extracted from a full data sheet with the same type number and title. For detailed information see the relevant data sheet or data handbook.

Limiting values definition — Limiting values given are in accordance with the Absolute Maximum Rating System (IEC 60134). Stress above one or more of the limiting values may cause permanent damage to the device. These are stress ratings only and operation of the device at these or at any other conditions above those given in the Characteristics sections of the specification is not implied. Exposure to limiting values for extended periods may affect device reliability.

Application information — Applications that are described herein for any of these products are for illustrative purposes only. Philips Semiconductors make no representation or warranty that such applications will be suitable for the specified use without further testing or modification.

13. Disclaimers

Life support — These products are not designed for use in life support appliances, devices, or systems where malfunction of these products can reasonably be expected to result in personal injury. Philips Semiconductors customers using or selling these products for use in such applications do so at their own risk and agree to fully indemnify Philips Semiconductors for any damages resulting from such application.

Right to make changes — Philips Semiconductors reserves the right to make changes in the products - including circuits, standard cells, and/or software - described or contained herein in order to improve design and/or performance. When the product is in full production (status 'Production'), relevant changes will be communicated via a Customer Product/Process Change Notification (CPCN). Philips Semiconductors assumes no responsibility or liability for the use of any of these products, conveys no license or title under any patent, copyright, or mask work right to these products, and makes no representations or warranties that these products are free from patent, copyright, or mask work right infringement, unless otherwise specified.

14. Contact information

For additional information, please visit: <http://www.semiconductors.philips.com>

For sales office addresses, send an email to: sales.addresses@www.semiconductors.philips.com

15. Contents

1	Product profile	1
1.1	General description	1
1.2	Features	1
1.3	Applications	1
1.4	Quick reference data	1
2	Pinning information	2
3	Ordering information	2
4	Marking	2
5	Limiting values	3
6	Characteristics	5
7	Application information	10
8	Package outline	11
9	Packing information	12
10	Revision history	13
11	Data sheet status	14
12	Definitions	14
13	Disclaimers	14
14	Contact information	14



© Koninklijke Philips Electronics N.V. 2004

All rights are reserved. Reproduction in whole or in part is prohibited without the prior written consent of the copyright owner. The information presented in this document does not form part of any quotation or contract, is believed to be accurate and reliable and may be changed without notice. No liability will be accepted by the publisher for any consequence of its use. Publication thereof does not convey nor imply any license under patent- or other industrial or intellectual property rights.

Date of release: 4 October 2004
Document number: 9397 750 13595

Published in The Netherlands